



Speaker

REPUBLIC OF NAURU

Government Gazette

Published by Authority

No. 46

26th August, 1981

Nauru.

G.N. No. 256/1981

DECEASED ESTATE (PERSONALTY)

Nauru Lands Committee advises that the trustee of Selso Eoaeo be now transferred to the Grand-Mother.

<u>DECEASED</u>	<u>SOURCE OF INCOME</u>	<u>BENEFICIARIES</u>	<u>SHARE</u>
V. Eoaeo	Investment	Selso Eoaeo (Eiyedada Eoaeo Trustee)	ALL

Distribution of the Estate will be effected fourteen days after this Gazette dated 24th August 1981.

G.N. No. 257/1981

NOTICE OF CORRIGENDUM

In the determination of the beneficiaries of the Estate of late L.D. Heinrich published in Gazette notice No. 237/1981 41 page 1 include.

<u>DECEASED</u>	<u>SOURCE OF INCOME</u>	<u>BENEFICIARIES</u>	<u>SHARE</u>
L.D. Heinrich	Passbook 2642	D. Dongobir	1/4

B.Y. UERA,
CURATOR OF INTESTATE ESTATES.

G.N. No.258 /1981

Determination of the Beneficiaries of the Estate of the late Eidumuteang D of Nibok District.

E S T A T E

1. The Nauru Lands Committee has ascertained that the late Eidumuteang D had been determined by the decisions of the Nauru Lands Committee (or its predecessor the Lands Committee to be the owner of the following lands:-

District	Portion No.	Type of Land	Name of Land	Notice of Ownership	Share
Aiwo	206	C.L.	Yangor	44/69	1/20
Aiwo	210	C.L.	Bubum	44/69	1/20
Aiwo	227	C.L.	Yangor	44/69	1/20

G.N. No.259 /1981

DETERMINATION OF BENEFICIARIES

2. The Nauru Lands Committee has determined that the beneficiaries of the estate of the late Eidumuteang D. are

(a) in respect of the land shown in paragraph 1 above:

District	Portion No.	Name of Land	Beneficiaries	Share
Aiwo	206	Yangor	Walter Detiyogo (LTO)	1/20
Aiwo	210	Bubum	As for portion 206 Aiwo	
Aiwo	227	Yangor	As for portion 206 Aiwo	

NOTE:

The Nauru Lands Committee's decision as to the beneficiaries of the estate of Eidumuteang was published in Gazette No. 28/72.

Any person who is dissatisfied with the distribution of the above estate may appeal to the Supreme Court within 21 days of the publication of this Gazette.

J.A. DAGUAPE
VICE CHAIRMAN.

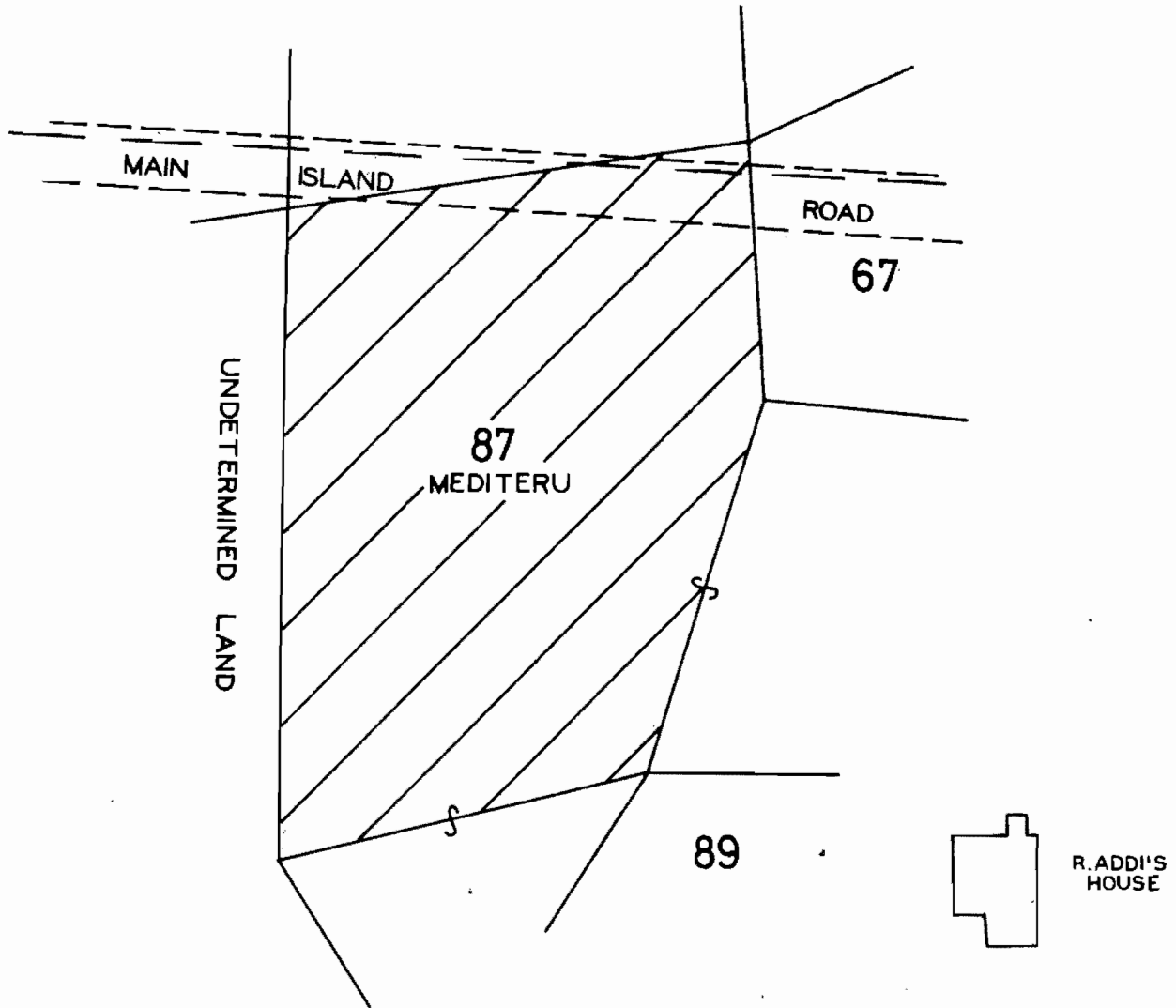

CLASSIFICATION OF LAND

BY VIRTUE of the powers vested in me by SECTION 7 of the LANDS ACT 1976, I HEREBY classify the land shown hatched on the plan herein as NON-PHOSPHATE BEARING.

[Signature]
(HAMMER DEROBURT)
MINISTER

FOR ISLAND DEVELOPMENT & INDUSTRY



DISTRICT OF UJUW

SCALE: 50' = 1"

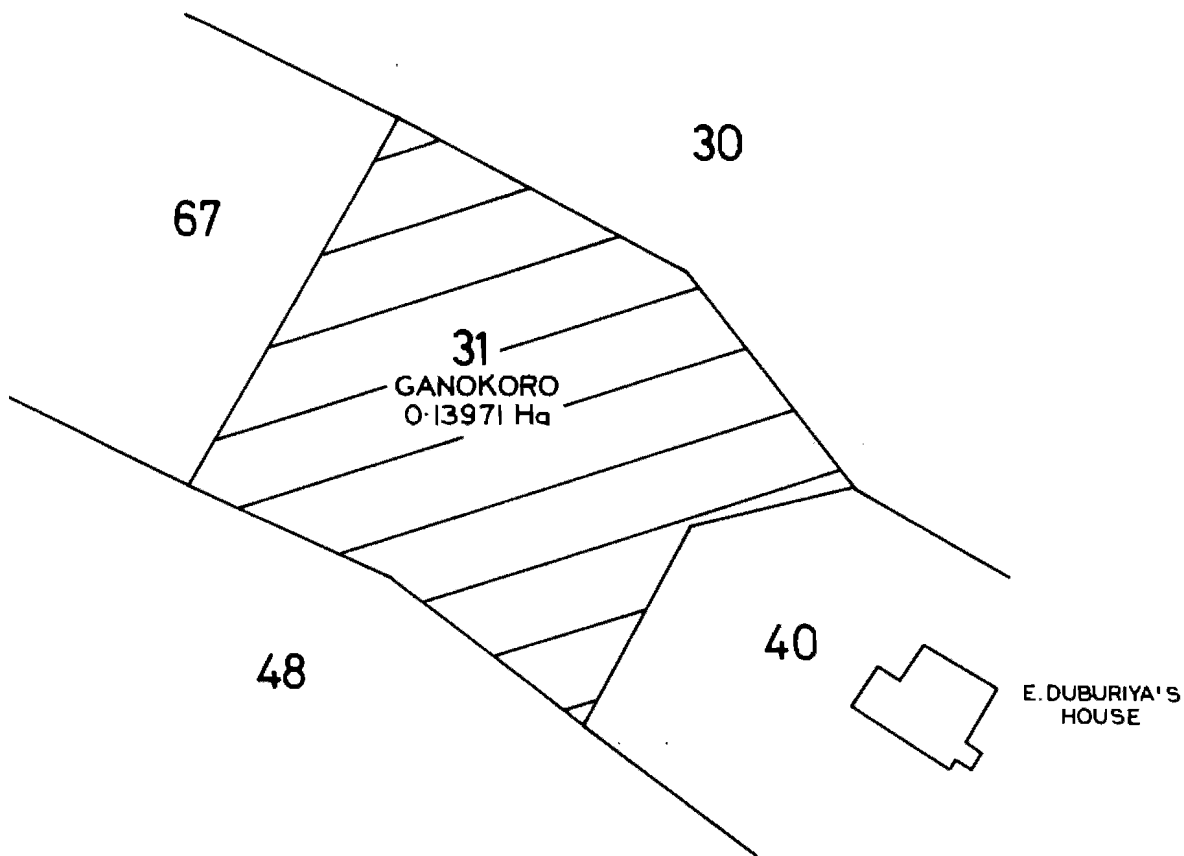

CLASSIFICATION OF LAND

BY VIRTUE of the powers vested in me by SECTION 7 of the LANDS ACT 1976, I HEREBY classify the land shown hatched on the plan herein as NON-PHOSPHATE BEARING.

Hammer Derobert
 (HAMMER DEROBURT)
 MINISTER

FOR ISLAND DEVELOPMENT & INDUSTRY



DISTRICT OF MENENG
SCALE: 50' = 1"

G.N. No. 262 / 1981.

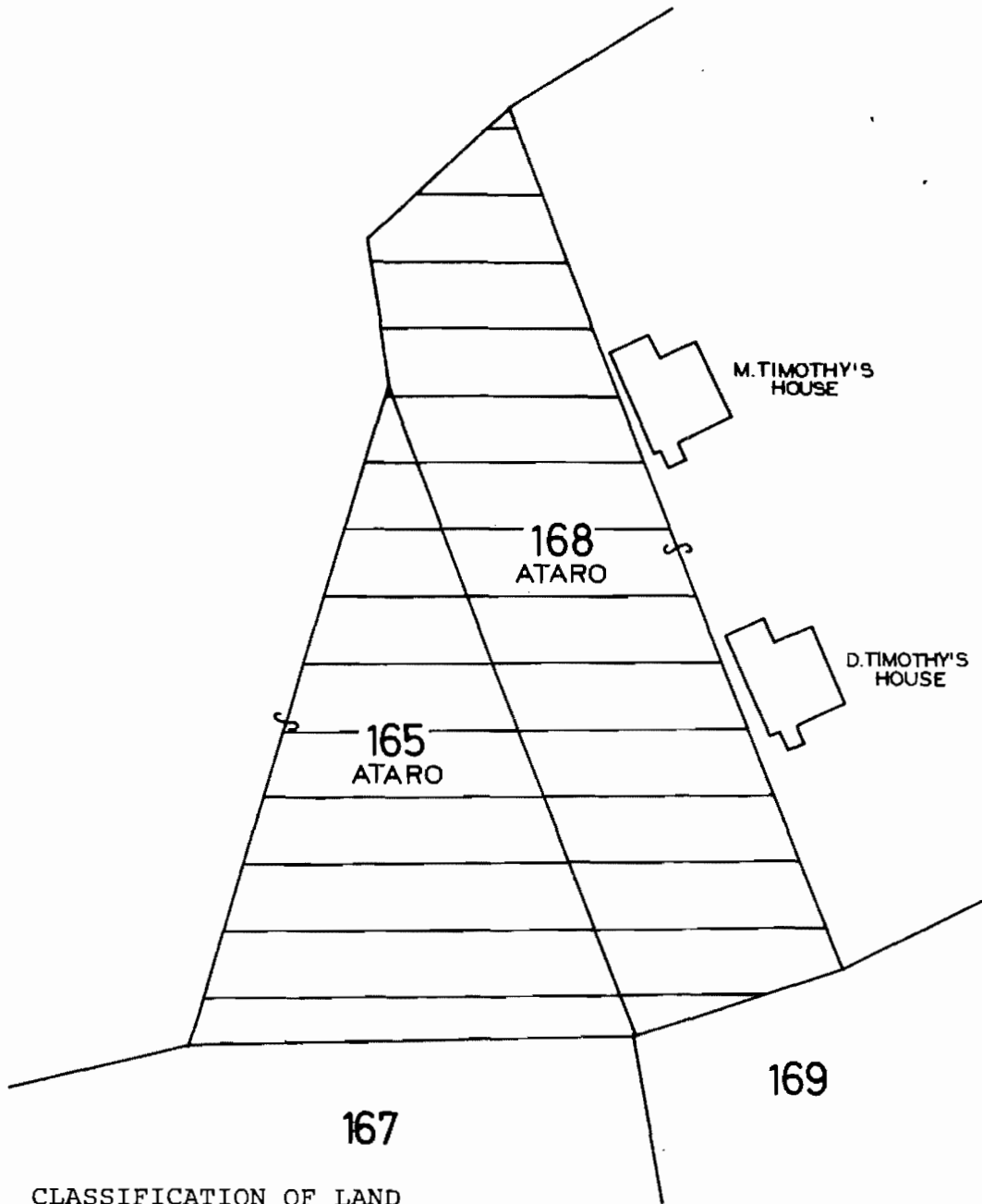

CLASSIFICATION OF LAND

BY VIRTUE of the powers vested in me by SECTION 7
of the LANDS ACT 1976, I HEREBY classify the land
shown hatched on the plan herein as NON-PHOSPHATE
BEARING.

(HAMMER DEROUBURT)
MINISTER

FOR ISLAND DEVELOPMENT & INDUSTRY



DISTRICT OF BUADA
SCALE: 50' = 1"

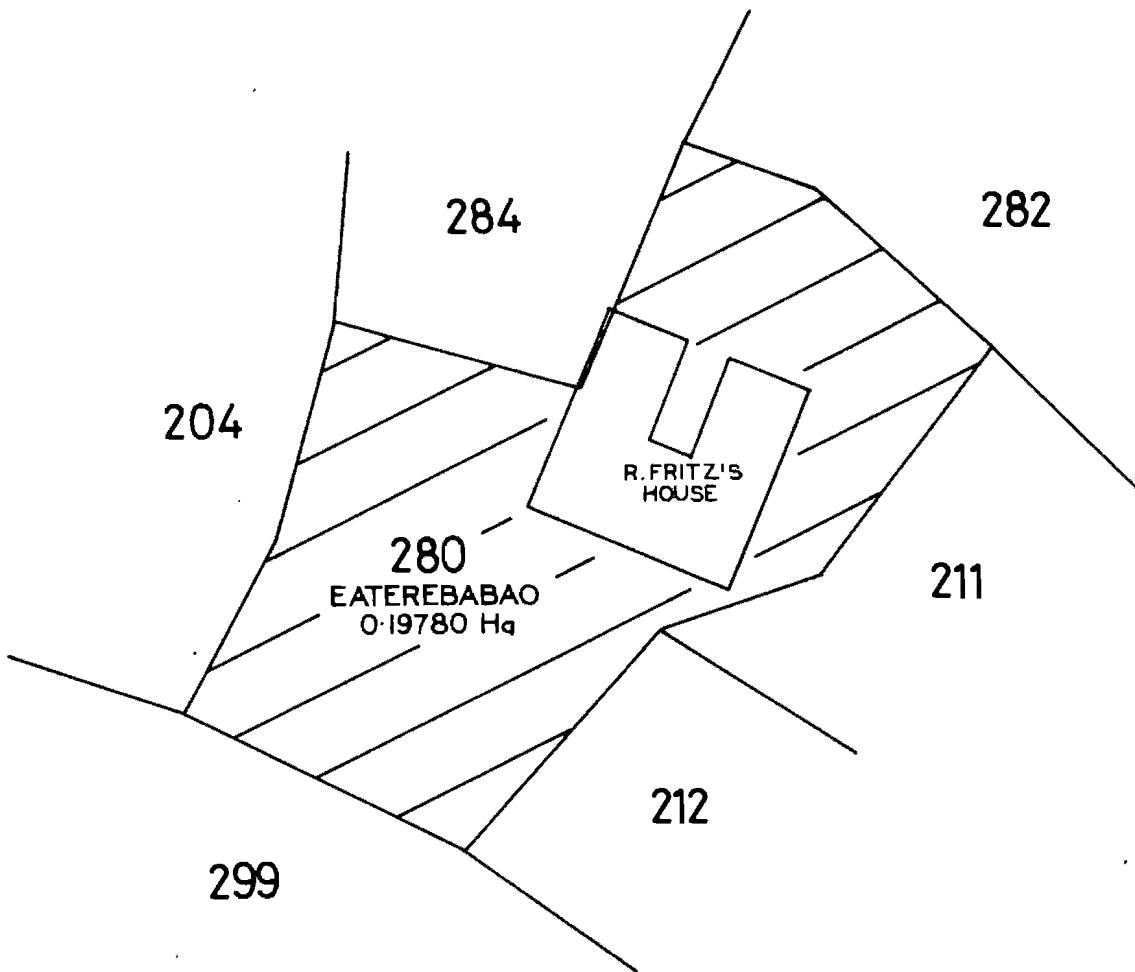

CLASSIFICATION OF LAND

BY VIRTUE of the powers vested in me by SECTION 7 of the LANDS ACT 1976, I HEREBY classify the land shown hatched on the plan herein as NON-PHOSPHATE BEARING.



(HAMMER DEROUBURT)
MINISTER

FOR ISLAND DEVELOPMENT & INDUSTRY

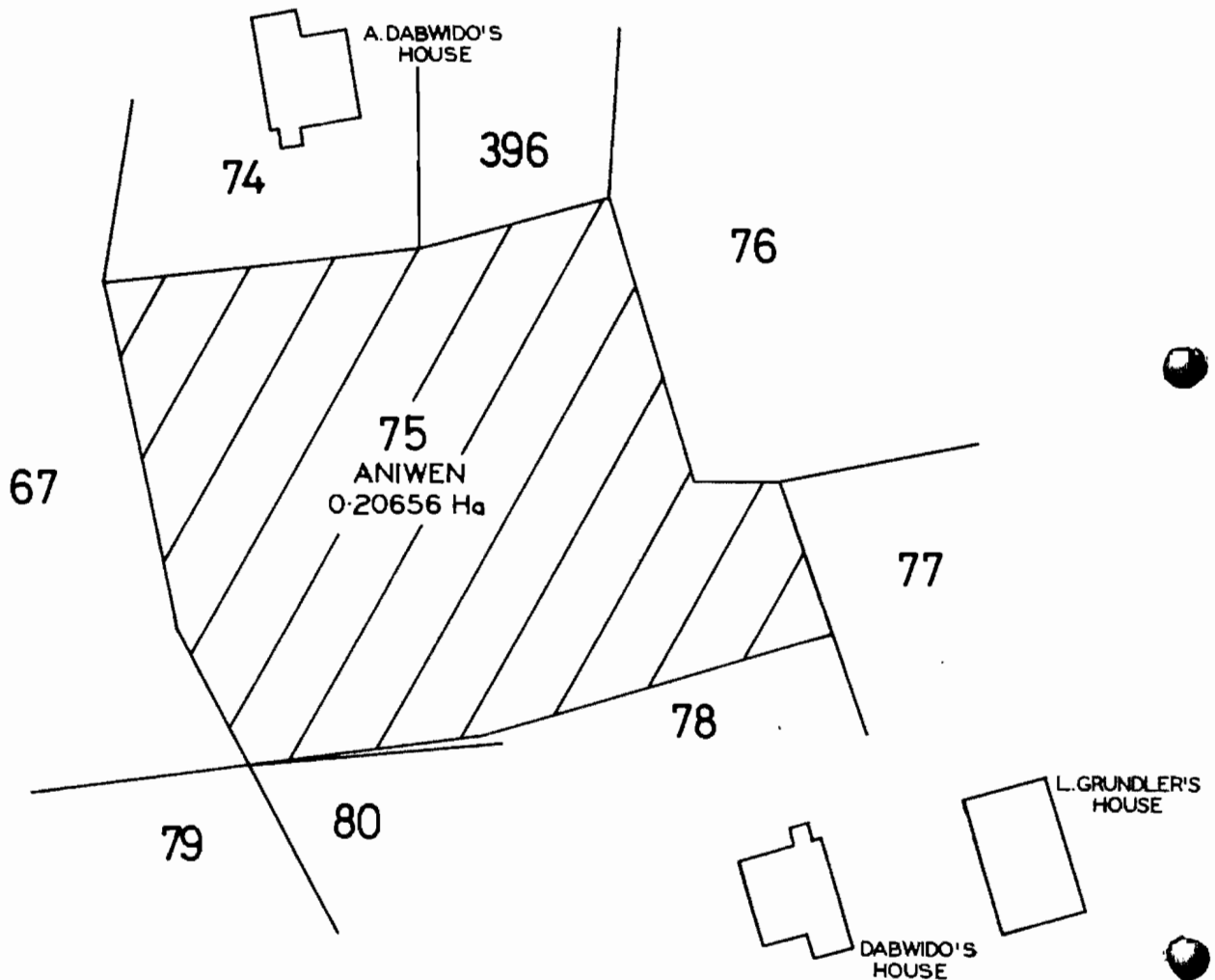

DISTRICT OF MENENG
SCALE : 50' = 1"

G.N. No. 264 /1981.



CLASSIFICATION OF LAND

BY VIRTUE of the powers vested in me by SECTION 7 of the LANDS ACT 1976, I HEREBY classify the land shown hatched on the plan herein as NON-PHOSPHATE BEARING.



(HAMMER DEROUBURT)
MINISTER

FOR ISLAND DEVELOPMENT & INDUSTRY

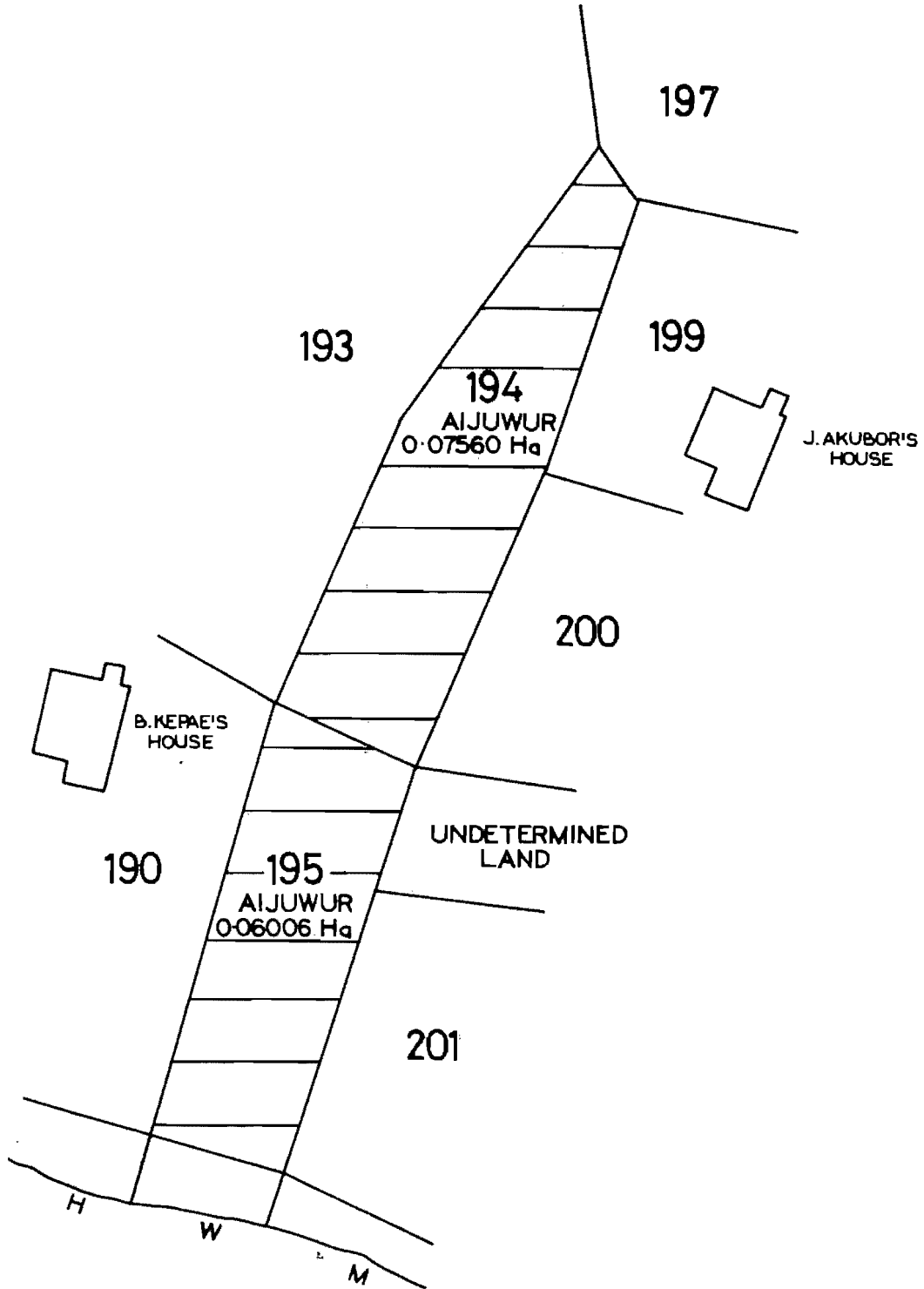

DISTRICT OF YAREN

SCALE : 50' = 1"



CLASSIFICATION OF LAND

BY VIRTUE of the powers vested in me by SECTION 7 of the LANDS ACT 1976, I HEREBY classify the land shown hatched on the plan herein as NON-PHOSPHATE BEARING.

(Signature)
 (HAMMER DEROBURT)
 MINISTER

FOR ISLAND DEVELOPMENT & INDUSTRY



DISTRICT OF ANABAR
SCALE: 50' = 1"

G.N. No. 266 /1981.

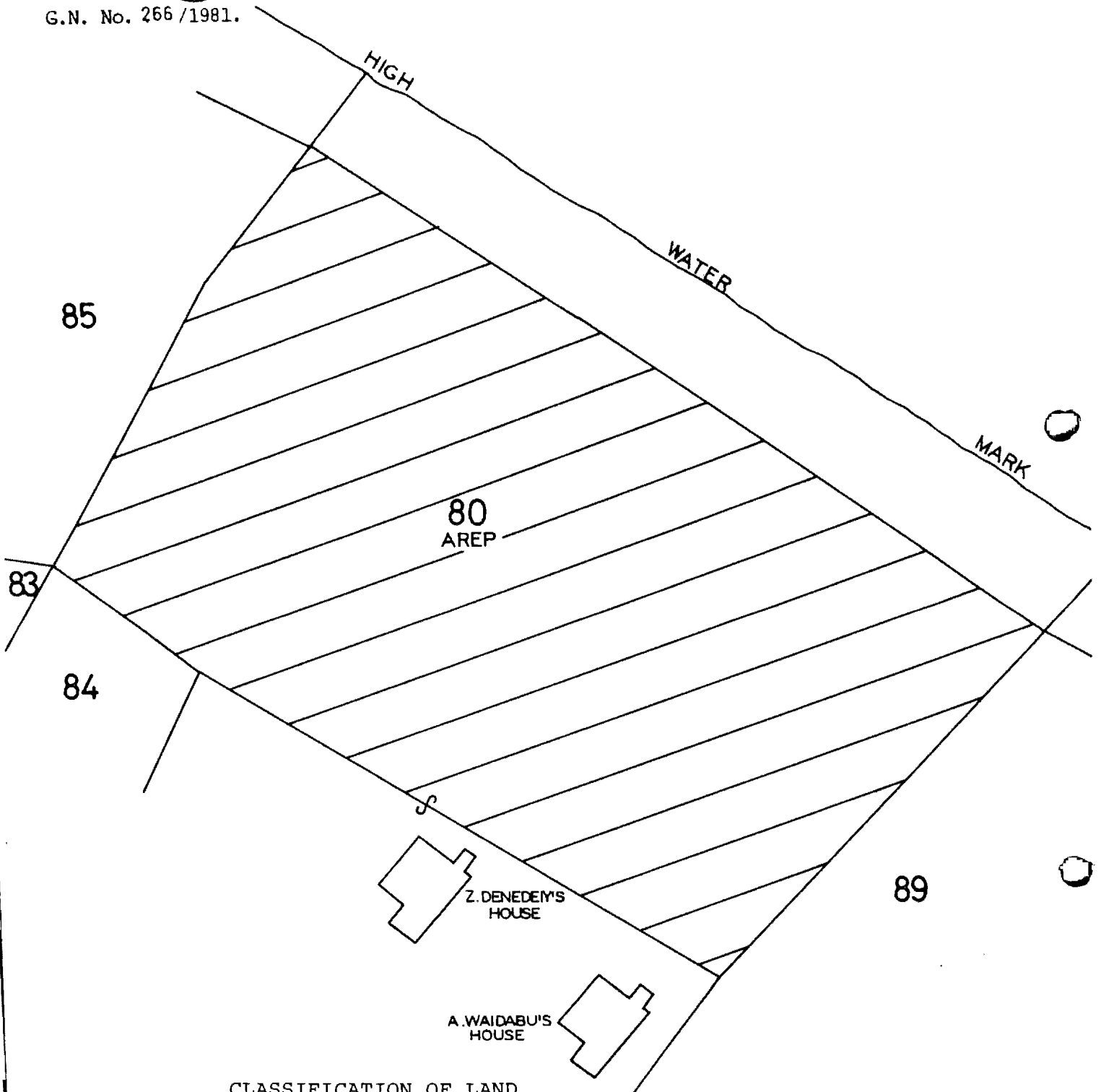

CLASSIFICATION OF LAND

BY VIRTUE of the powers vested in me by SECTION 7 of the LANDS ACT 1976, I HEREBY classify the land shown hatched on the plan herein as NON-PHOSPHATE BEARING.



(HAMMER DEROUBURT)
MINISTER

FOR ISLAND DEVELOPMENT & INDUSTRY

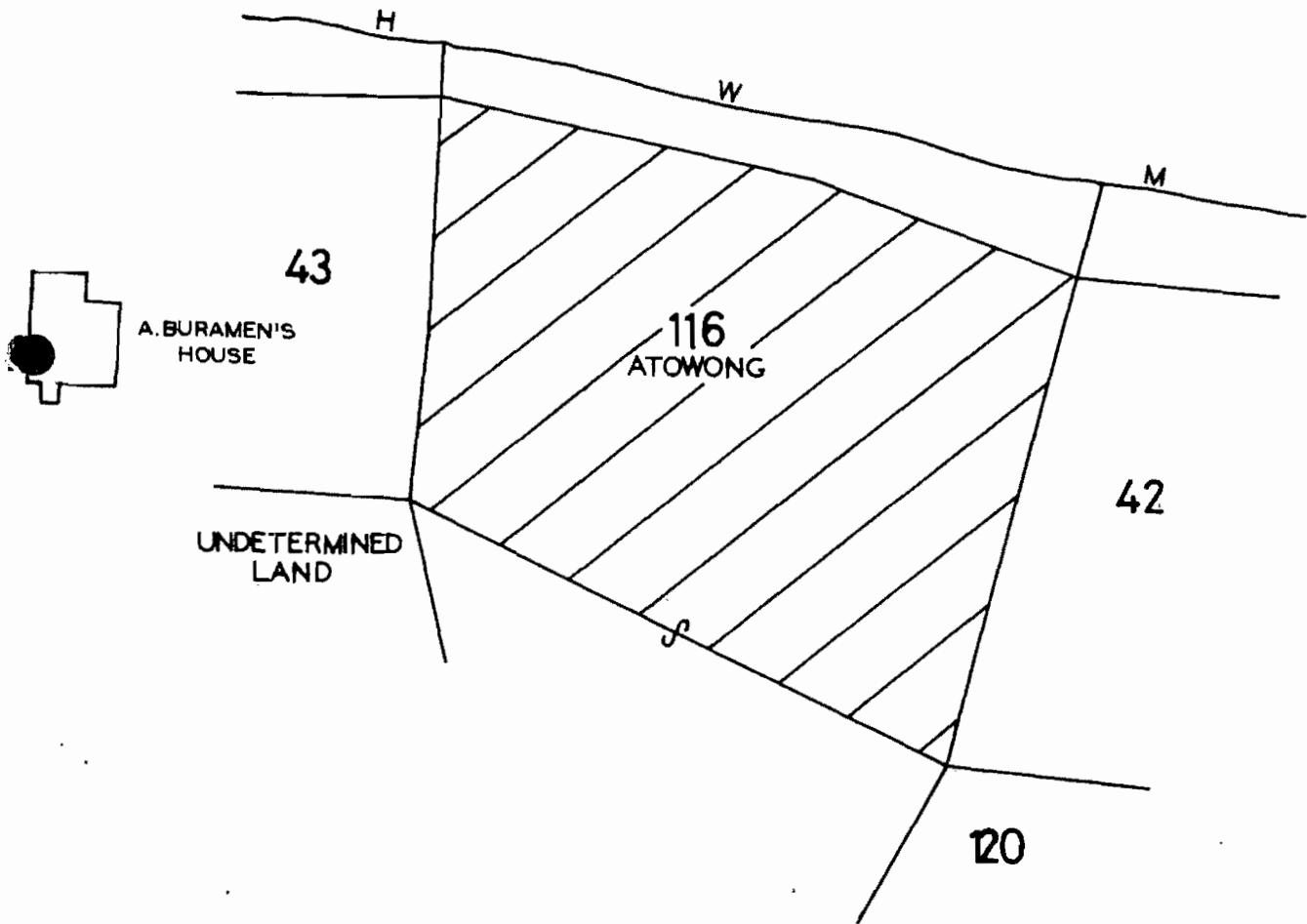

DISTRICT OF ANETAN
SCALE: 50' = 1"

G.N. No.267 /1981.



CLASSIFICATION OF LAND

BY VIRTUE of the powers vested in me by SECTION 7 of the LANDS ACT 1976, I HEREBY classify the land shown hatched on the plan herein as NON-PHOSPHATE BEARING.

(HAMMER DEROBURT)
MINISTER

FOR ISLAND DEVELOPMENT & INDUSTRY